



Alfa-MOS Technology Corp.
闡能科技股份有限公司

Company Profile



Alfa-MOS Technology Corp.

Jan. 2019



- **Alfa-MOS Technology Corp.** is established in 2010, Taipei, Taiwan. Company is near to **Taipei NanKang Sofeware Park (NKSP)**.
- **Alfa-MOS Technology Corp.** specializes intellectual properties in the development of Advance Power MOSFET & Power Management ICs.
- All of product in **Alfa-MOS Technology Corp.**, the is applied in wide electronic field, including portable electronic equipment, PC, Notebook ...etc.
- Specially, the LED Lighting & E-bike, **Alfa-MOS Technology Corp.** do the effort to support the high voltage& Ultra-Low RDS(on) Power MOSFET.
- To offer the Halogen-Free and Excellent property products, **Alfa-MOS Technology Corp.** contributes to “**Green Product**”, the product are qualified by **SGS** and meets **ROHS** specifications.





Alfa-MOS Technology Corp.
闡能科技股份有限公司

Headquarter



2F., No.80, Sec. 1, Cheng Kung Road, Nan Kang Dist., Taipei City 115, Taiwan
115台北市南港區成功路一段80號2樓 **TEL.:+886-2-2651-3928**

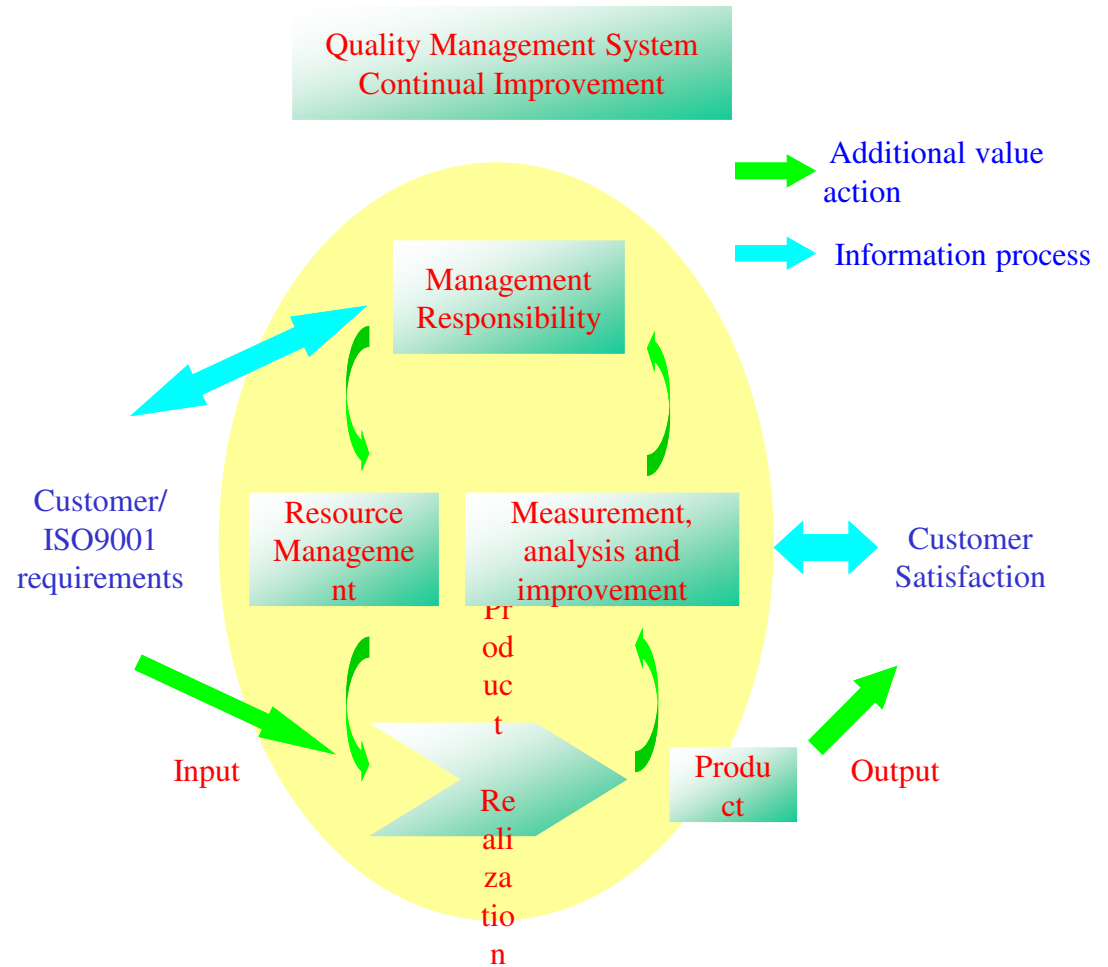

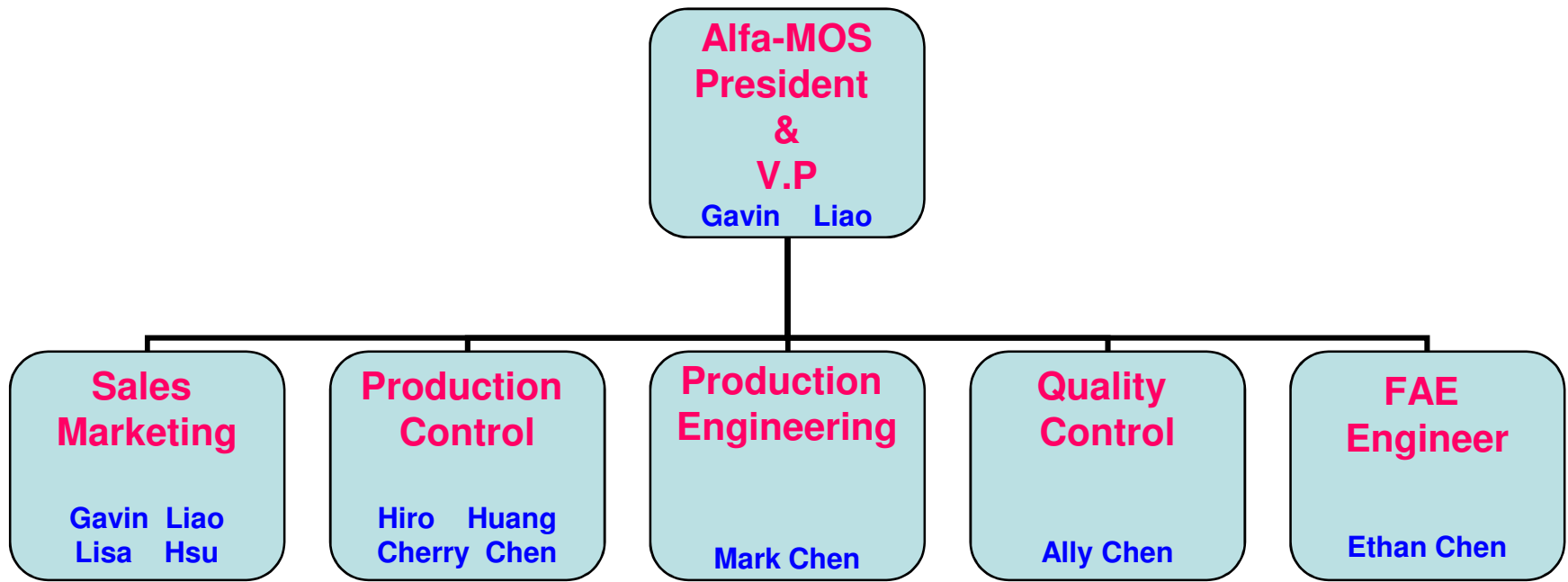



ROHS Specification

Cadmium	< 100 ppm
Hg	< 1000 ppm
Lead (Pb)*	< 1000 ppm
Hexavalent Chromium (Cr6+)	< 1000 ppm
Poly Brominated Biphenyls (PBB)	< 1000 ppm
Poly Brominated Diphenyl Ethers (PBDE)	< 1000 ppm

Green Specification

Bromine	< 900 ppm
Chlorine	< 900 ppm
Total Bromine and Chlorine	1500 ppm max
Antimony	< 900 ppm





 **Wafer Foundry**

- MOSEL Vitelic Inc.
- Episil Technologies Inc.
- Lite-On Semiconductor Corp.
- Vanguard International Semiconductor Corporation

 **Wafer Testing**

- Micro Silicon Elecs. Corporation

 **Assembly & FT**

- Jiangsu Changjiang Electronics Technology Co. Ltd.
- Shanghai SIMAT Microelectronics Technology Co.LTD
- Great Team Backend Foundry (Dongguan), ltd.



Factory	Website
Mosel Vitelic Inc.(台灣茂矽電子股份有限公司)	http://www.mosel.com.tw/
Lite-On Semiconductor Corp.(敦南科技股份有限公司)	http://www.liteon-semi.com/
Vanguard International Semiconductor Corporation (世界先進積體電路股份有限公司)	http://www.vis.com.tw/
Episil Technologies Inc.(漢磊科技股份有限公司)	http://www.episil.com/
Micro Silicon Elecs. Corp.(台灣微矽電子股份有限公司)	http://www.msec.com.tw/
Jiangsu Changjiang Electronics Technology Co. LTD.(江蘇長電科技股份有限公司)	http://www.cj-elec.com/
Shanghai SIMAT Microelectronics Technology Co.LTD(上海芯哲微電子科技有限公司)	http://www.simat-sh.com/
Great Team Backend Foundry (Dongguan), ltd.(杰群電子科技(東莞)有限公司)	http://www.gtbf-ltd.com/



- **ISO Certified Supply Chains**

EPI Wafer Manufacturer : ISO 9001 Certified ISO 14001 Certified QS 9000 Certified Health and Safety Certified	Wafer Foundry : ISO 9001 Certified TS16949 Certified ISO 14001 Certified ISO Guide 25 Certified
Assembly House : ISO 9002 Certified TS 16949 Certified ISO 14001 Certified QS 9000 Certified	Alfa-MOS : ISO 9001 Certified



Product Family

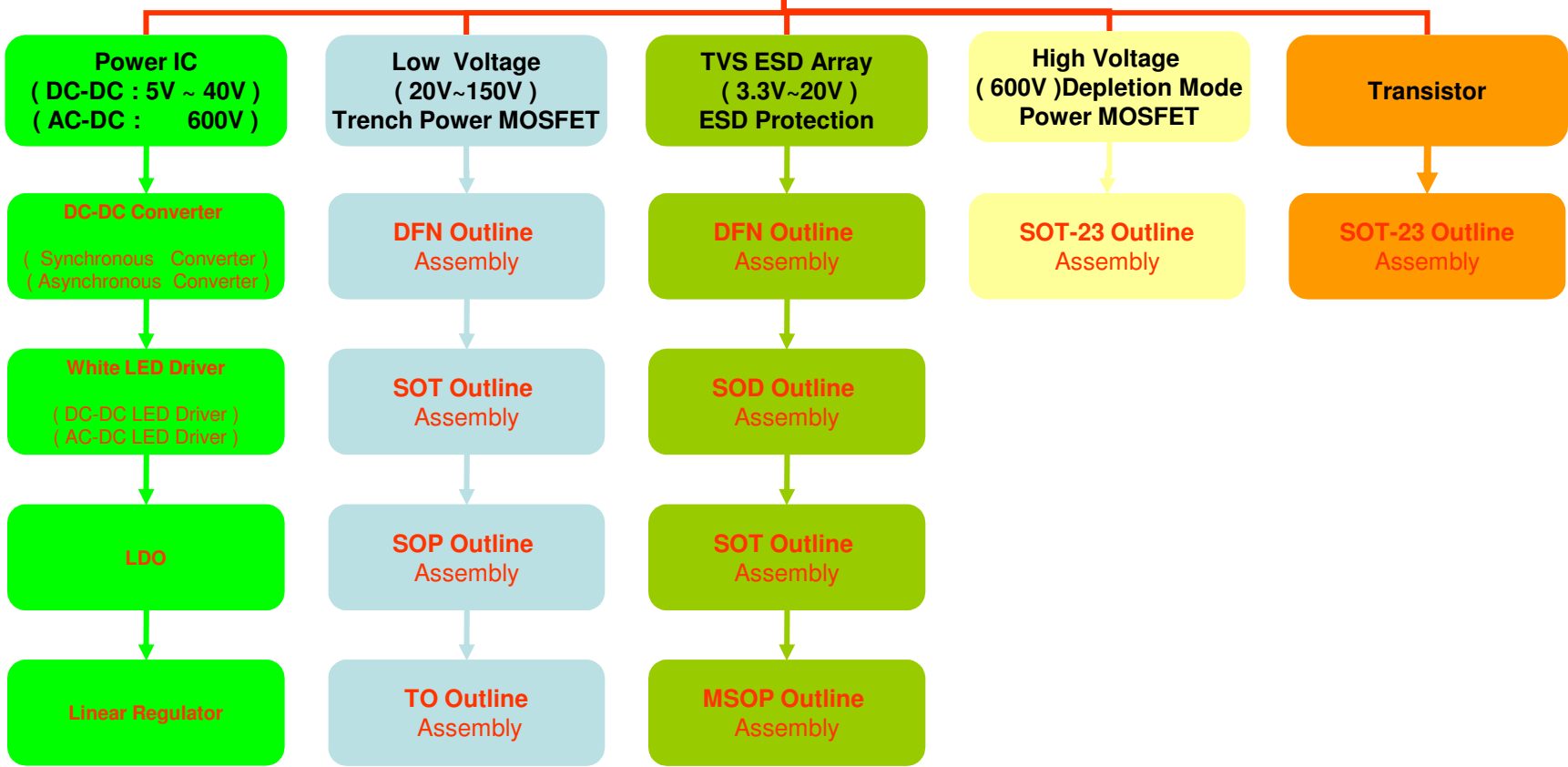

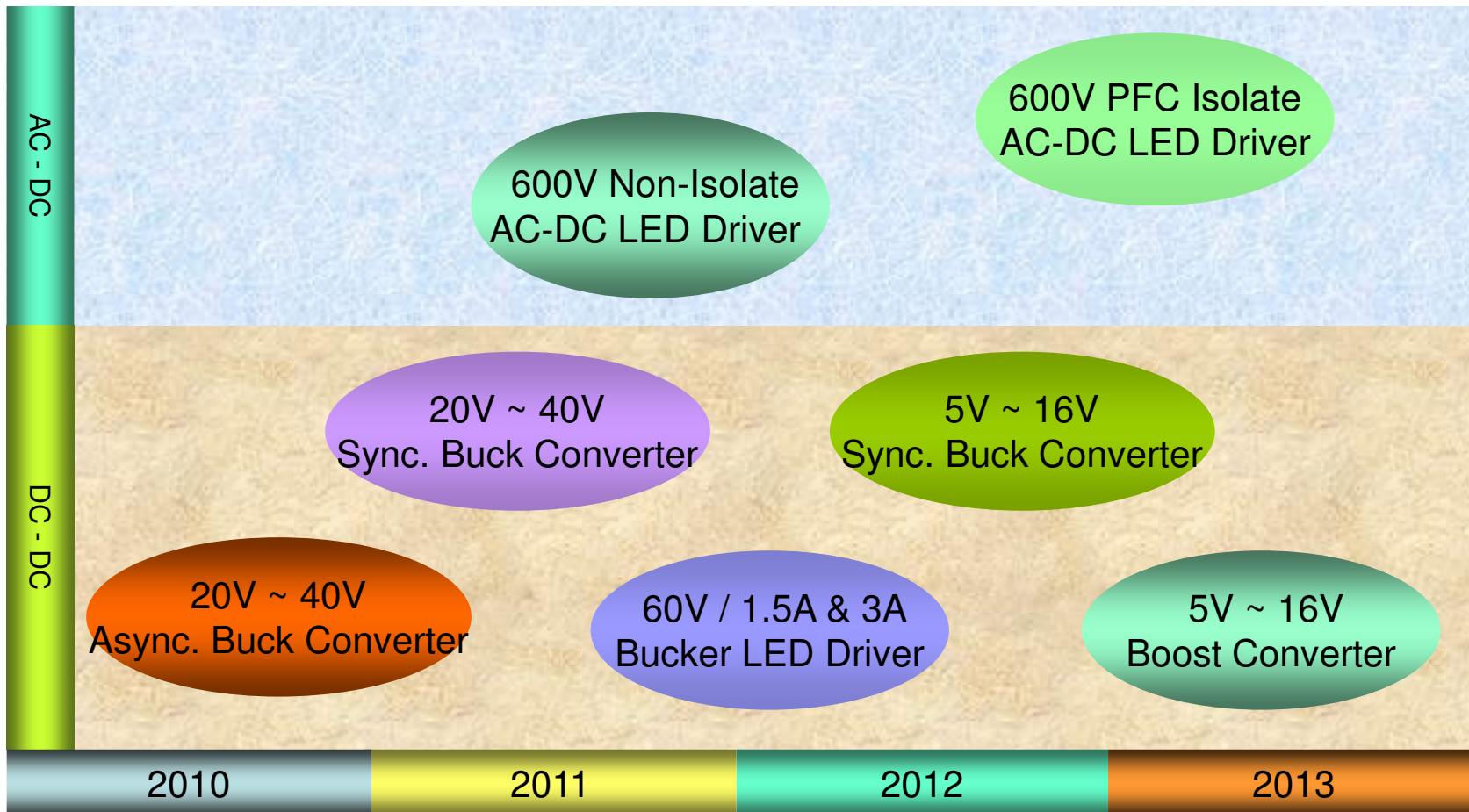

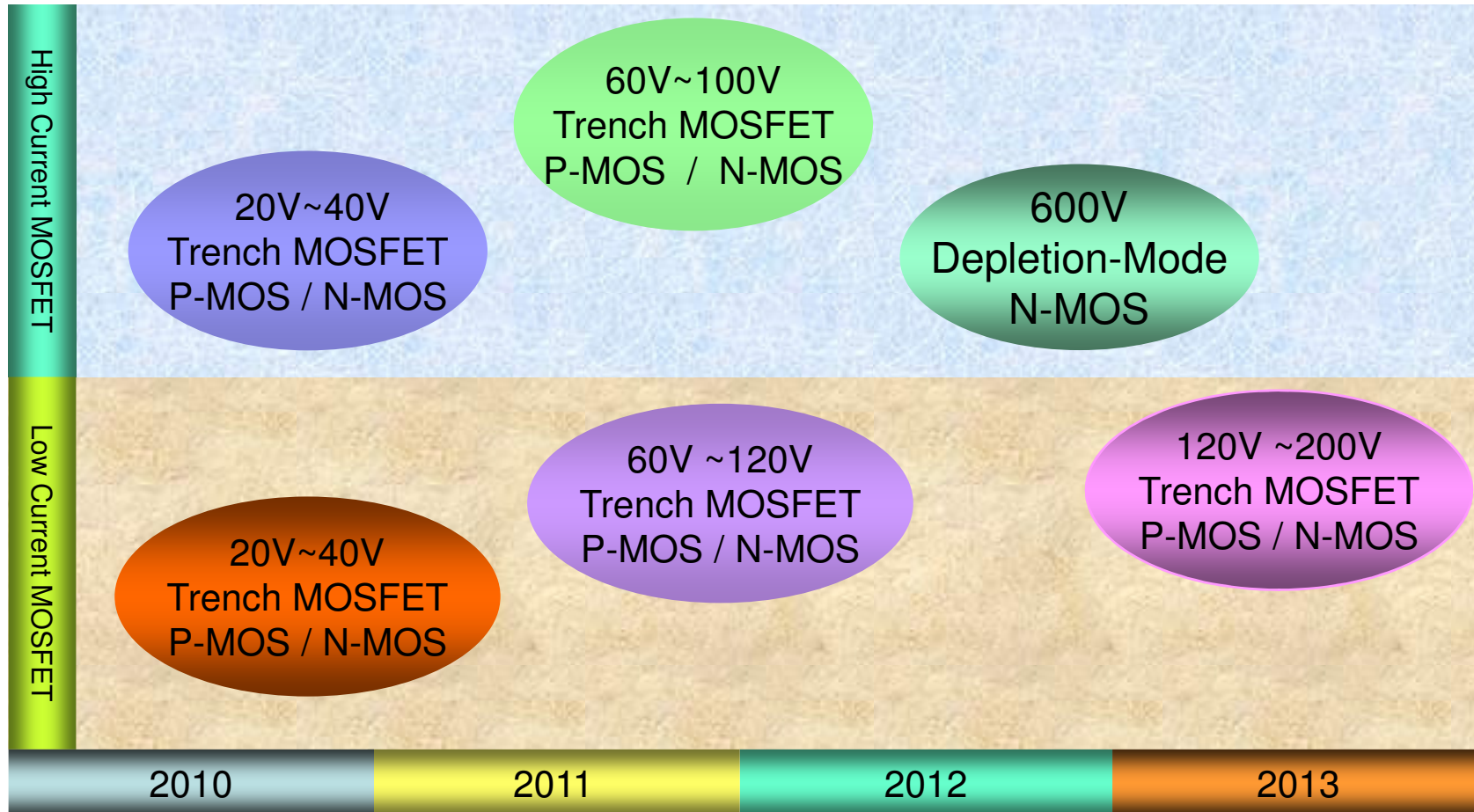

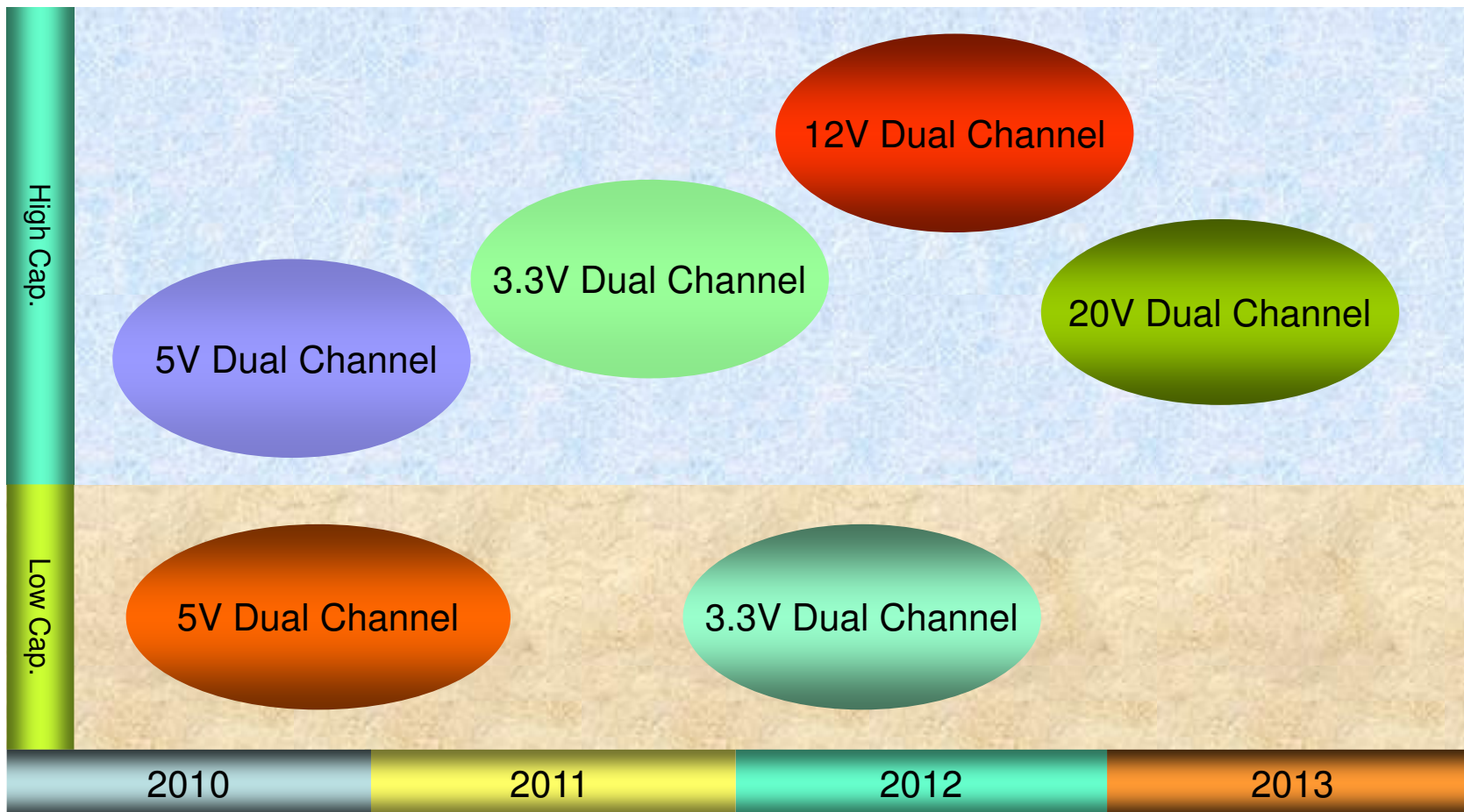



Alfa-MOS Technology Corp.
闡能科技股份有限公司

Marketing





Alfa-MOS Technology Corp.
闡能科技股份有限公司

Power Management IC Application



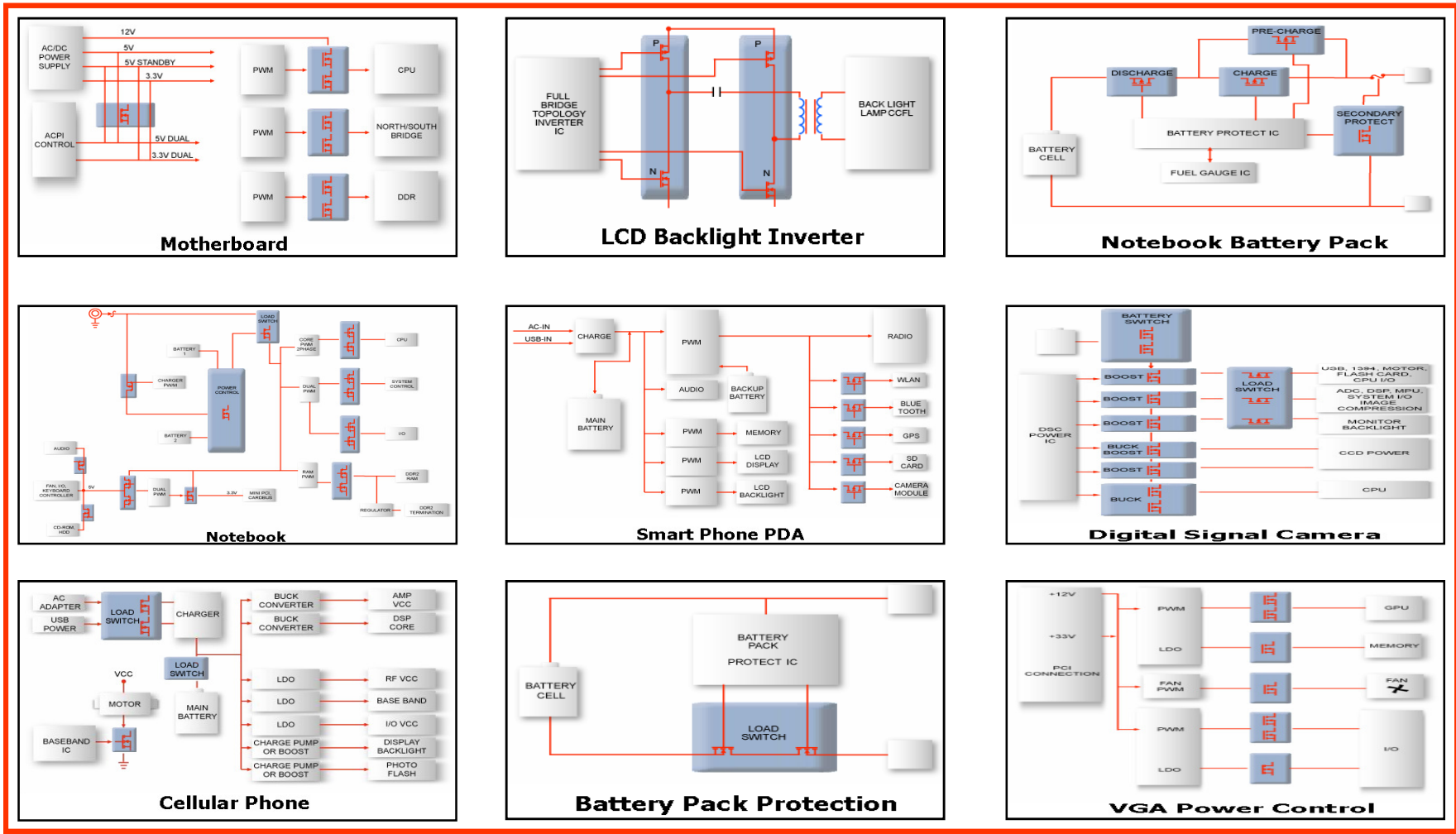

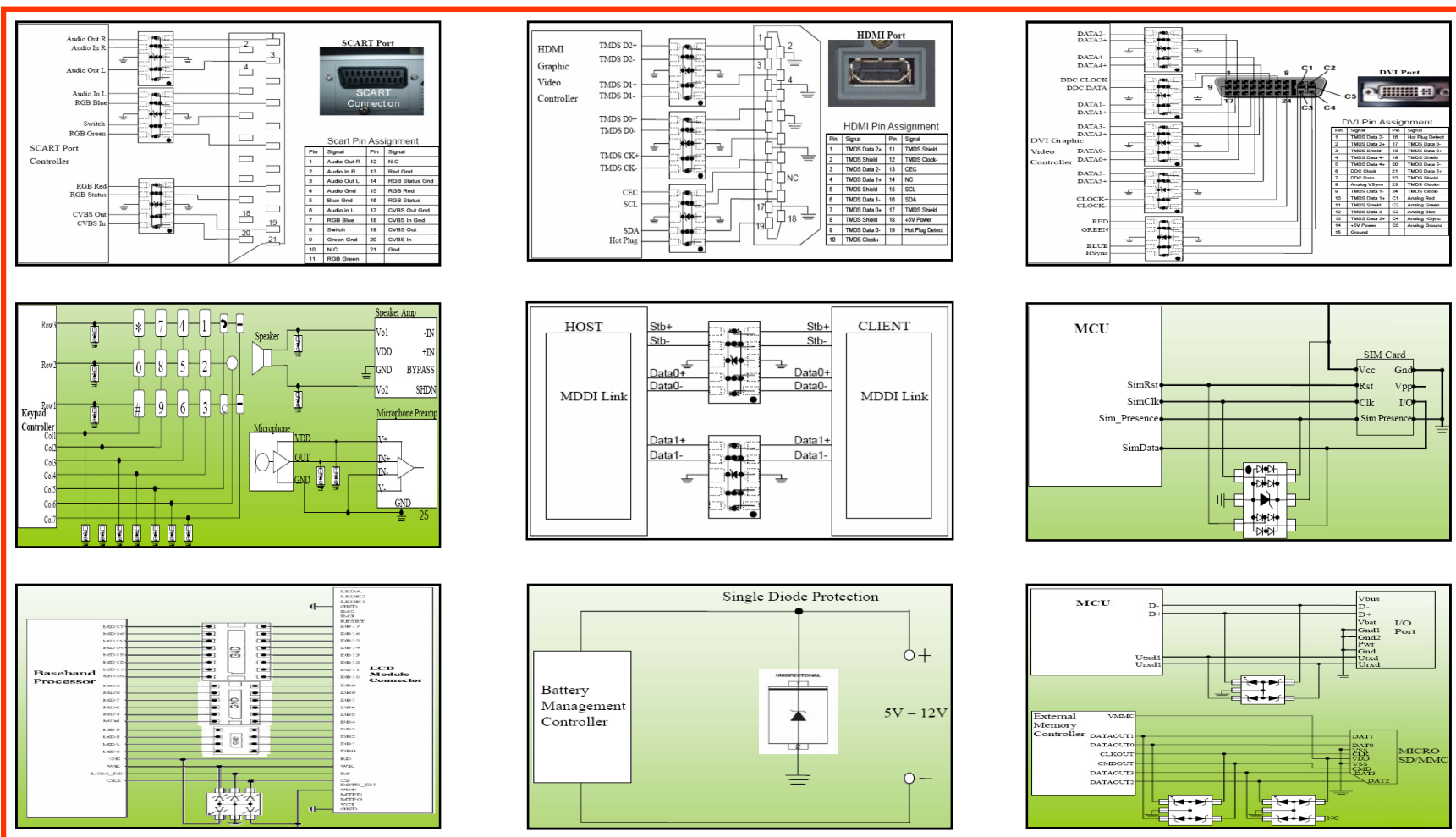



Alfa-MOS Technology Corp.
 闡能科技股份有限公司

Major Customer

(Taiwan / Korea / Japan / Canada)

Getac

神基科技股份有限公司

HUMAX

www.humaxdigital.com



科技股份有限公司



泰金寶電通

DynaPack

順達科技股份有限公司
 www.dynapack.com.tw



www.memoryexpertsinc.com



合世生醫科技股份有限公司



Raritan.

荷蘭商瑞力登國際有限公司



www.spinmaster.com



APack

典暉科技股份有限公司



德立斯科技股份有限公司



www.hi-mix.com.br



環天世通科技股份有限公司



群利科技股份有限公司



巨輪興業股份有限公司



陞泰科技股份有限公司



Alfa-MOS Technology Corp.
 闡能科技股份有限公司

Major Customer

(China)

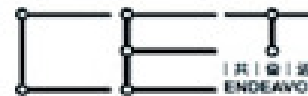

深圳市高普达科技有限公司

深圳市共奋进有限公司

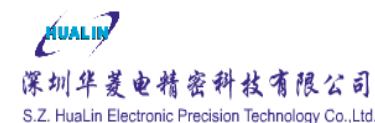

苏州和钧新能源有限公司

